

TIP SHEET



PUBLISHED BY BULLSEYE GLASS CO. 3722 SE 21ST AVENUE, PORTLAND, OR 97202 ©2001

WORKING WITH ACCESSORY GLASSES FUSED PATTERNS USING FRITS AND STRINGERS

At Bullseye we call the various non-sheet forms of our glass "accessory glasses." Two of our favorites are stringer and frit. Stringers are thin threads of glass which are available through your local Bullseye dealer. Stringers can also be easily made from sheet glass with a simple MAPP® gas or propane torch. Frits are granules of crushed glass which we manufacture in three different grain sizes and which, like stringer, are stocked by most Bullseye dealers.

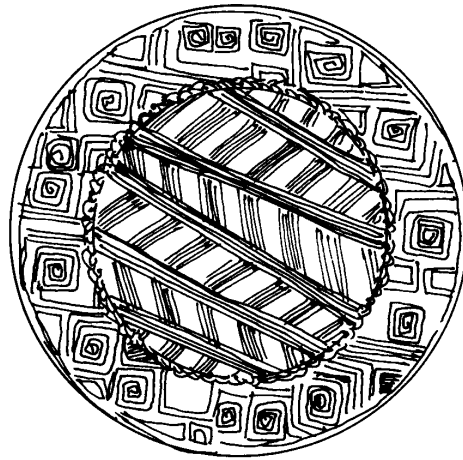

OZ DREAMS, 16" diameter bowl by Gritsch/McGregor, 1992

which come to mind as appropriate for fused pattern decoration.

SKILL LEVEL

We have assumed that our readers have basic kilnforming skills; that they are familiar with the basic equipment, firing and annealing of glass. If not, we suggest a beginning class through your local glass shop or pick up a copy of one of these books: *The Bullseye TechBook* by Bullseye Glass Co. or *Glass Fusing Book One* by Daniel Schwoerer and Boyce Lundstrom (These books are available at the Bullseye Resource Center).

INSPIRATION AND DESIGN

By using accessory glasses in combination with flat and textured sheet glass you can produce a variety of pattern and texture in kilnfired projects. The specific patterns and designs shown in this TipSheet were inspired by a recent trip to Australia. Aboriginal basketry, carving and painting, combined with the brilliant colors characteristic of much of contemporary Australian art were the genesis of the techniques illustrated here.

We chose a tile format to simplify the technical presentation. The materials and instructions which follow will produce three 5" x 17" tiles. Simple tiles have exciting architectural applications. They are weather- and water-resistant and make striking accents when used as borders or highlights in a field of ceramic tile. But consider incorporating these techniques in other objects. Think about using similar tiles in leaded work or inlaid into metal or woodworking projects. We have shown these patterns on a 16" diameter slumped bowl. But platters, picture frames, jewelry, boxes, and lighting fixtures are just a few of the many objects

KILNS, CONTROLLERS & TEMPERATURES

In the Bullseye kilnforming studio we have about 13 different kilns and a variety of controllers. Each has its own heating and cooling characteristics. For these projects we used and recommend a Paragon GL24 ADTSD. It is our favorite for most general applications. It heats quickly and evenly, has an easy-to-use controller and has proved to be extremely dependable over numerous firings.

The temperatures shown in the three tile projects which follow are those read by the controller on this specific kiln. All kilns are not created equal. We offer these temperatures only as suggestions. They may not be exactly appropriate for the kiln you are using. Know your kiln. Be familiar with its firing patterns. Read your manual. And if you don't already have it, visit our website (www.bullseyeglass.com) to download "TechNotes 1: Knowing Your Kiln."

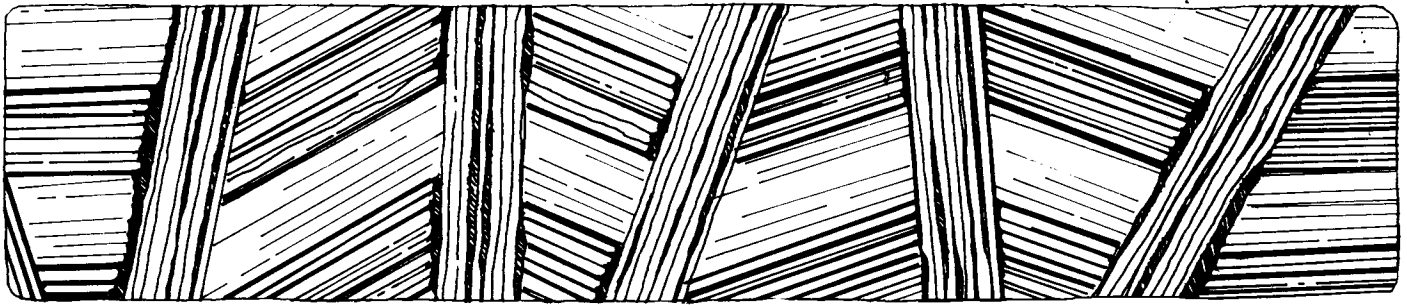

BASKETRY: STRINGERS & REED

Glass needed:

- Bullseye sheet glass, one each 5" x 17":
 - Jade green opal 0145-30F
 - Clear 1101-30F
 - One piece, 10" x 17" with grooves running lengthwise:
 - Clear thin reed 1101-53F
- Bullseye glass stringers:
 - Orange opal 0125-07
 - Red opal 0124-07
 - Yellow opal 0120-07

Other materials/equipment:

- Bullseye GlasTac
- Pattern paper
- Felt tip pen

You will need to do two separate firings to create the elements for the final firing of the "Basketry" tile:

1. Fully fuse the opal green and clear glass pieces to create a base tile with a flat surface.

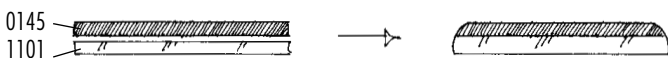

Fire to 1510°F (~820°C). Soak for 10 minutes.*

2. Tack fuse the yellow, orange and red stringers onto the clear thin reed glass.

The grooves in the surface of the clear reed glass hold the stringers in place during set-up and firing. Use a drop of GlasTac at each end of the stringers to tack the

stringers down and prevent shifting. A stringer makes a handy dropper for applying the GlasTac.

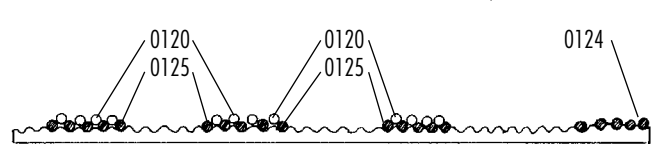

Fire to 1300°F (~700°C). Soak for 20 minutes.*

3. Using a ruler and stencil knife, cut out pattern pieces which match your design. Position these pattern pieces upside down on the back side of the tack-fused glass, aligning the stripes with the stringer stripes in the glass, and mark their outlines with a felt tipped pen. Cut out the glass shapes.

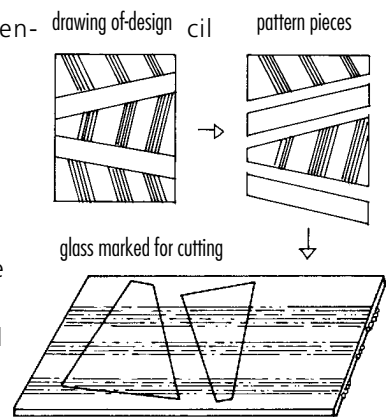

4. Position the glass shapes on the base tile.

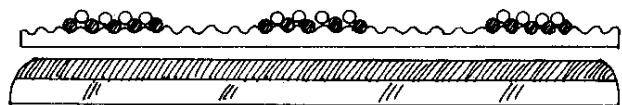

Apply an overglaze (Spray A or Superspray).

Fire to 1470°F (800°C). Soak for 3 minutes.*

***IMPORTANT FIRING NOTE:**

In the instructions above — as in the subsequent two tiles — we have shown the soak temperatures and times only. Since all firings are based on the same initial heating and annealing cycles, these are not included for every firing.

On all firings we took 120 minutes to reach 1100°F (~590°C); then fired as quickly as possible up to

the soak temperature given in the individual instructions.

The annealing cycle consisted of allowing the kiln temperature to drop (with the door closed) at its own rate down to 1050°F (~565°C). We took 60 minutes to ramp down to 940°F (~505°C). We soaked for 60 minutes at 940°F (~505°C). Then ramped down to 700°F (~370°C) over a period of 100 minutes. The kiln then cooled to room temperature at its own rate.

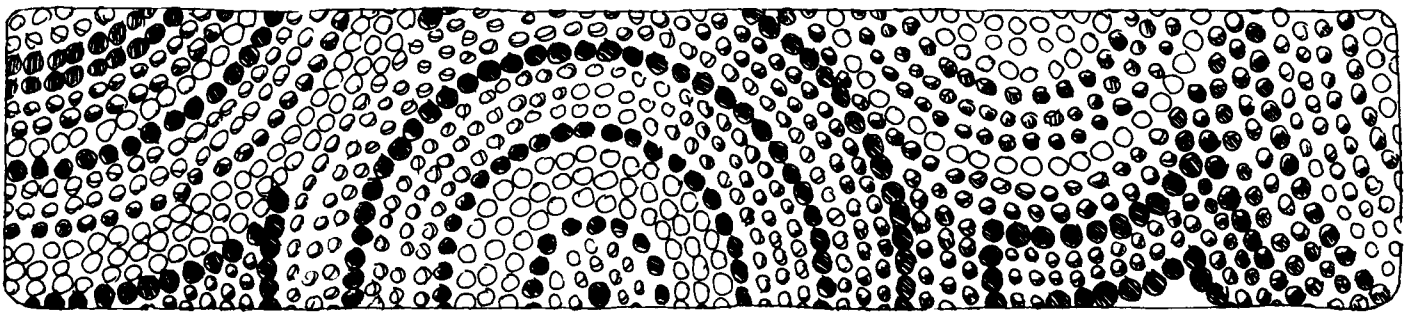

BEAD IT, BEAD IT, BEAD IT: STRINGERS TO BEADS

Glass needed:

- Bullseye sheet glass, one each 5" x 17"

Spring green opal	0126-30F
Clear	1101-30F

- Bullseye glass stringers:

Black	0100-07
Yellow opal	0120-07
Red opal	0124-07
Orange opal	0125-07
Neo-lavendar opal	0142-07
Jade green opal	0145-07

Other materials/equipment:

- Bullseye GlasTac
- Propane or MAPP® gas torch
- Sheet metal

You will need to prepare two separate elements before the final firing of the "Beaded" tile.

1. Fully fuse the spring green opal and clear glass pieces to create a base tile with a flat surface.

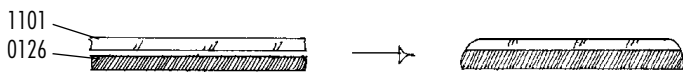

Fire to 1510°F (~820°C). Soak for 10 minutes.*

2. Prepare a palette of colored glass balls (~4mm diameter). These can be produced in either of two ways.

- Fire glass frit on a kiln shelf which has been coated with shelf primer. At full fusing temperature — 1510°F (~820°C) — the frit granules will ball up on the shelf. There are two disadvantages to making the balls in this way. 1) the glass (especially opals) will pick up shelf primer, and 2) the balls will be of various sizes.
- Cleaner and more uniform balls can be made by heating stringer over a gas flame (a propane torch works, MAPP® gas is better) until a small ball of glass drops off the end of the stringer.

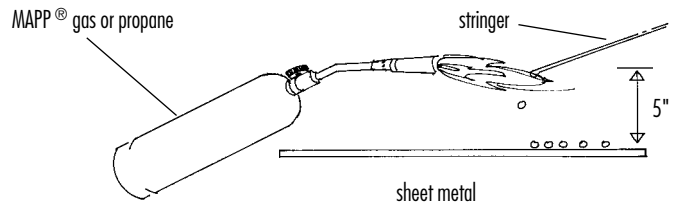

It is easiest to use ready-made stringers (available at your Bullseye glass supplier), but if stringers are not available in the colors you need, they are easily made by pulling them from 1/4" wide strips of Bullseye sheet glass.

Use a stringer as a punty. Heat the tip of a glass strip until it balls up in the flame. Attach the stringer-punty and pull out the molten ball. The slower you pull, the thicker the stringer diameter will be.

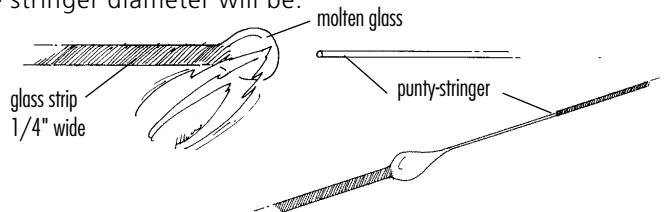

NOTE: glass can reduce or discolor in the gas flame. To-avoid this, work only in the tip of the flame where the atmosphere is more oxidizing.

Dropping bead balls:

If right-handed, hold the torch in your left hand, the stringer in your right hand.

Work the stringer and flame about 5" above a sheet metal surface.

You should be able to make about 10 bead balls out of each 12" stringer. With practice you can make about 300 balls per hour.

3. Position the bead balls on your base tile using GlasTac to hold them in place.

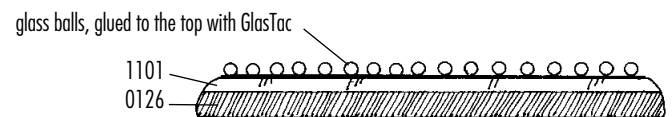

Apply an overglaze (Spray A or Superspray).

Fire to 1470°F (800°C). Soak for 3 minutes.*

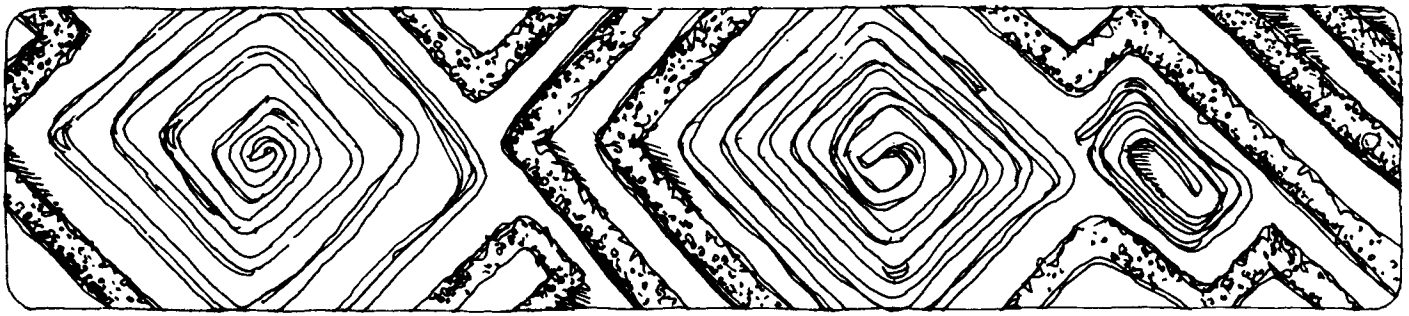

FRITS & STRINGERS: ANGULAR SPIRALS

Glass needed:

- Bullseye sheet glass, one each 5" x 17":

Steel blue opal	0146-30F
Clear	1101-30F

- Bullseye glass stringers:

All stringers for this tile were hand-pulled in order to achieve an irregular linear pattern. For a more uniform line, use ready-made Bullseye stringers (-07).

Black (sheet)	0100-30F
Yellow opal	0120-30F
Red opal	0124-30F
Turquoise opal	0116-30F

- Bullseye medium grade (-02) frit:

Red opal	0124-02F
Orange opal	0125-02F
Yellow opal	0120-02F

Other materials/equipment:

- Bullseye GlasTac
- Propane or MAPP® gas torch
- Sandblaster, sandblast resist

As in the previous tile you will need to prepare a base tile and hand-pulled stringers.

1. Fully fuse the steel blue opal and clear glass pieces to create a base tile with a flat surface.



NOTE: #0146-30 is Bullseye's most reducing glass. If not coated with overglaze or covered by clear sheet glass, the surface may metallize on firing.

Fire to 1510°F (~820°C). Soak for 10 minutes.*

2. Hand pull the stringers as shown in the earlier beaded tile instructions. Alternate the pulling speed to create an irregular stringer.

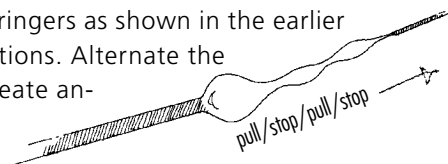

3. Bend the stringers into angular spirals over a weak flame. You may hold the stringers in your fingers or use long tweezers to avoid fingertip burns.

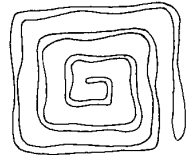

4. Prepare the base tile for firing:

- Prepare an exact drawing of your frit & stringer design.
- Apply the resist (contact paper or any good sandblast resist) to the clear surface of your pre-fired base tile.
- Either draw your design directly on the sandblast resist or transfer it onto the resist using carbon paper.
- Using a razor knife, cut out the resist in the areas where the frit will be placed. Sandblast grooves approximately 1/32" deep in these areas. Remove the resist.
- Clean the sandblasted base tile with water.
- Put GlasTac in the grooves.
- Fill the grooves with medium grade (-02) frit, applying more GlasTac as necessary to hold the frit in place.
- Use GlasTac to glue the stringer spirals to the surface.

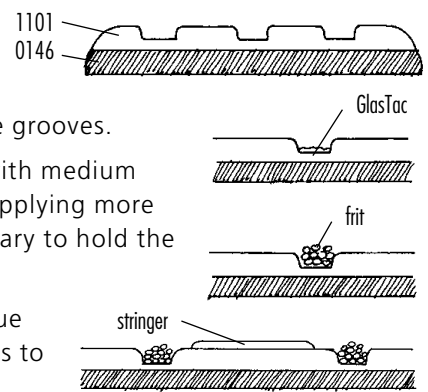

NOTE: Opal frits devitrify easily. It is imperative to apply an overglaze when using frits!

5. Fire to 1470°F (800°C). Soak for 3 minutes.*

Technical Notes by Rudi Gritsch.



BULLSEYE GLASS CO., 3722 SE 21st Avenue, Portland, OR 97202
 TEL (503) 232-8887 FAX (503) 238-9963
 sales@bullseyeglass.com
 www.bullseyeglass.com